

# INSTALLATION DETAILS

## 3053

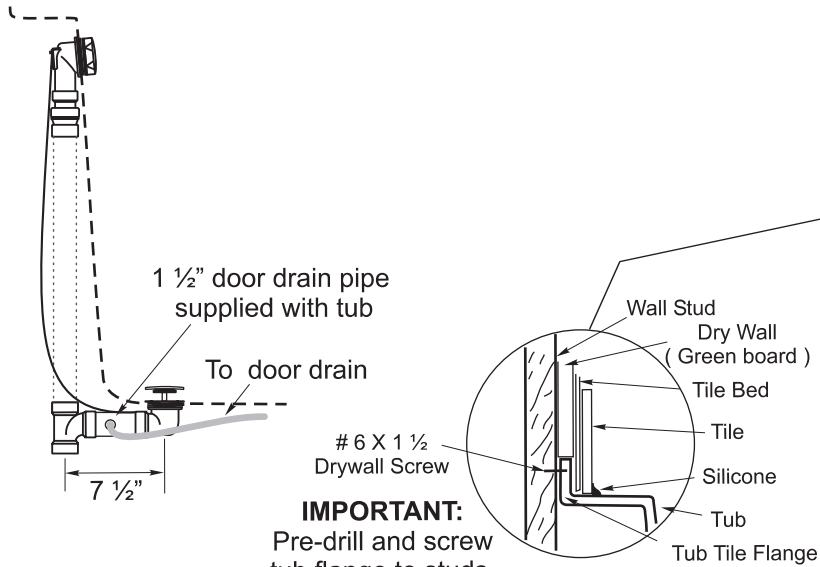

**IMPORTANT:**  
Pre-drill and screw tub flange to studs.  
**Do Not** force tub flange to studs, this will cause the tub door to leak.

